

Modification PB-1435E

Filter Unit, Yaesu FT-301D

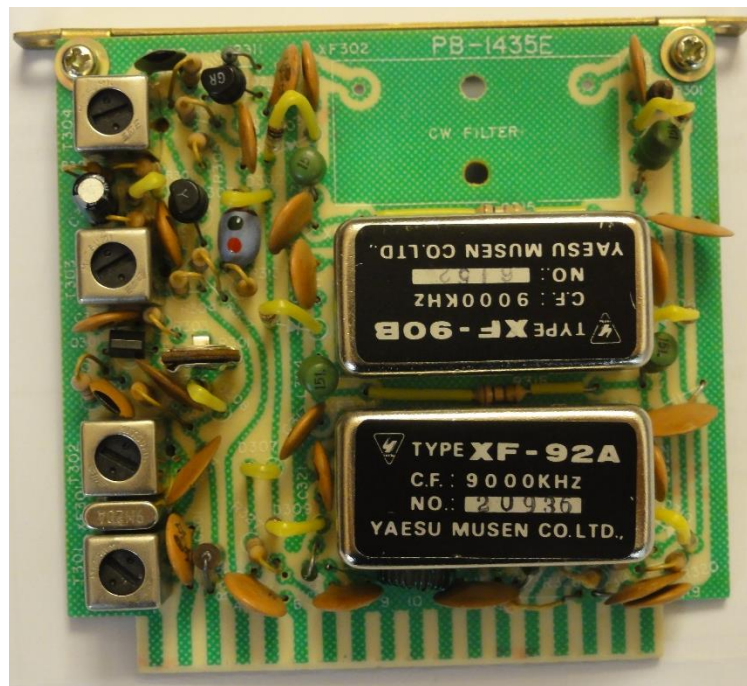

Modification instructions

Version 1.0b

January 19, 2021

Table of Comntents

1	Introduction	3
2	Parts lists.....	3
3	Modifying the filter unit	3
4	Operation / Adjustment	5
5	Disclaimer of liability	6



Important! Advices or tips for the correct function of the PB-1435E.



Caution! The instructions must be observed carefully.

1 Introduction

The standard SSB filter (XF-92A) is installed on the Filter Unit PB-1435E. Optionally an AM filter (XF-90B) and a CW filter (XF-90C) can be added.

All filters have an input and output resistance of 500Ω and must also see the correct load resistance for operation.

However, it was found that especially the filter edges of the SSB filter are not symmetrical to the 9MHz IF frequency. The reason is that the filter is only terminated on one side with approx. 500Ω. This results in distortion of the modulation during USB operation.

The following modification fixes this error.

2 Parts lists

piece	components No.	Description
3	R1, 2, 3	560Ω 1/4 W (green-blue-brown) [Component 1]
1	R311	1kΩ 1/4 W (brown-black-red) [Component 1]
3	L1, 2, 3	150μH (Component L302, L304, L306) [Component 2]

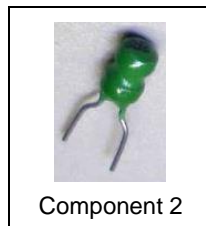
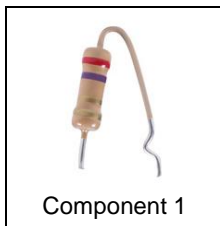

3 Modifying the filter unit

The "Filter Unit" must be removed from the device, as this is the only way to carry out the necessary interventions.

All modifications should be carried out and inspected using the "PB-1435E" Filter Unit schematic.

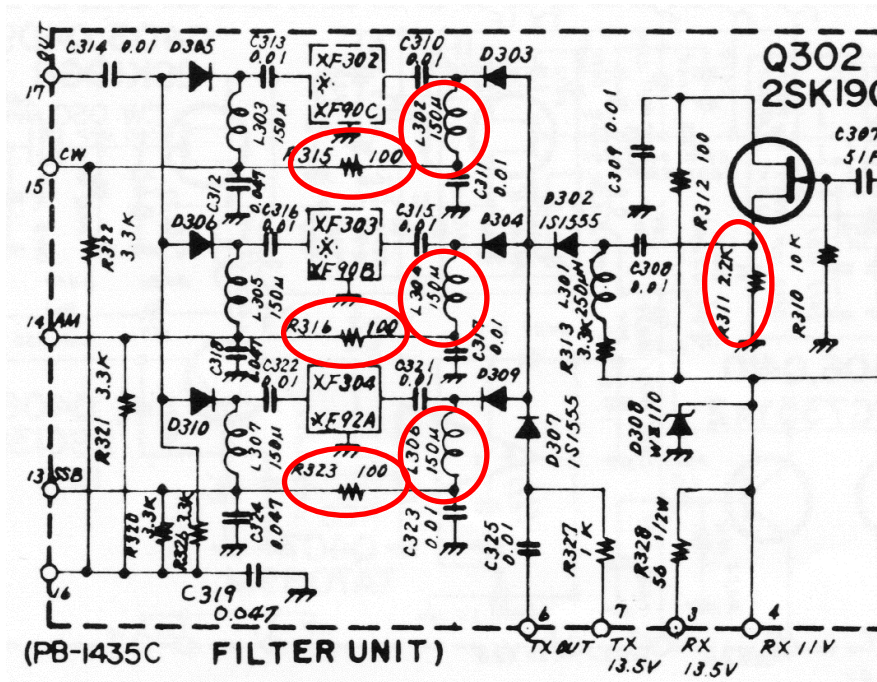

Figure 1

PCB layout "Filter Unit" (seen from above) Red = Remove elements

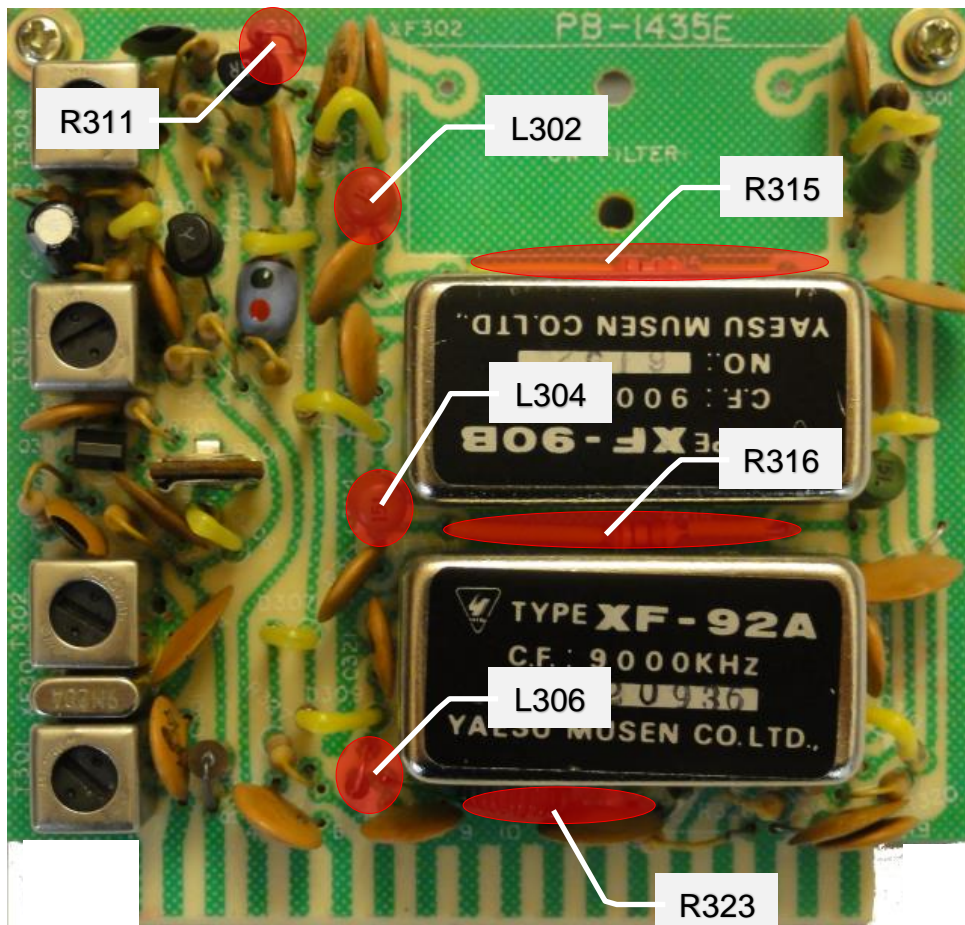



Figure 2

- Carefully remove the 3 chokes L302, L304 and L306 (150 μ H).
 -  Attention: The choke coils are reused.
- Remove the 4 resistors R315, R316, R323 (100 Ω) and R311 (2.2k Ω).
- Solder in the 3 resistors (560 Ω) at the positions of the previously removed inductors L302, L304 and L306.
 -  Do not throw away the cut-off connecting wires.
- Solder the resistor (1k Ω) to position R311.
- Take the 3 choke coils and solder on the back of the PB-1435E board at the positions of the resistors R315, R316 and R323, as shown in Figure 3. For the wiring of the AM and CW filter coils connected in series, you can use the cut-off wires of the resistors. The insulation tube comes from the removed resistors R315 and R316.
- All the modifications made by YAESU must not be changed.

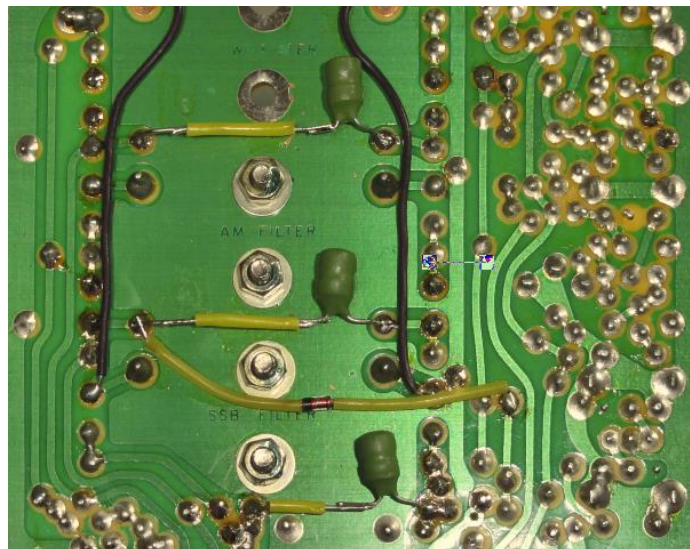

Figure 3

4 Operation / Adjustment

- The modification is now completed a special adjustment is not necessary.
- Insert the PB-1435E board back into your FT301.
- Carry out the adjustment according to the manual for the "EXITER, DRIVE LEVEL".

5 Disclaimer of liability

Any actions based on the information contained in this document are taken at the user's own responsibility. Any liability is excluded, both for direct and indirect damages and consequential damages that may arise in connection with the use of the information contained in this document.